

# Linx 9900 Series



9900 | 9910 | 9920 | 9940 | 9940 Spectrum

Product Brochure



Making printing one less thing to worry about

# Putting you first since 1987

From the very beginning, Linx has been built around you. Since 1987, we've earned a reputation for delivering reliable coding and marking solutions by listening to our customers and understanding their needs.

Every step of our journey has been shaped by your feedback, your challenges, and your expectations — because putting you first is not just what we do, it's who we are.

## Built on trust, evolved for you

Linx has long been recognised for producing reliable, easy-to-use CIJ printers that our customers trust.

This product is the next evolution—developed directly from customer feedback and designed to solve the challenges you face every day. It retains everything you love about Linx: dependable performance, intuitive operation, and proven quality.

Now enhanced with features to maximise uptime and simplify coding—making printing one less thing to worry about.



Discover the Linx 9900 Series



Linx 9900 Series continuous ink jet printer

Linx Iris® vision system

Linx SureClean® printhead wash station

9000 Series

## The Linx 9900 Series



**Linx 9900**  
Reliable everyday coder



**Linx 9910**  
Flexible coder for higher throughput



**Linx 9920**  
Increased print capability with less maintenance



**Linx 9940**  
Fast coding in demanding applications



**Linx 9940 Spectrum**  
High contrast coding on dark products

# Production managers have enough worries.



Linx has created the **9000 Series** so printing is not one of your worries.

## No more worries

about lost production time

The Linx 9000 Series eliminates unplanned downtime with automatic printhead cleaning and backup battery power.



## No more worries

about slow changeovers

The Linx 9000 Series maximises your changeover efficiency with fast line changes on battery power and easy connectivity options.



## No more worries

about rework, rejects or fines

The Linx 9000 Series ensures every code is present and correct with a simple vision system and intuitive interface.



## No more worries

about operating costs

The Linx 9000 Series reduces running costs on ink, solvent and printer maintenance.



Making printing one less thing to worry about

# Automatic printhead cleaning to **eliminate downtime**

- 1** Insert the printhead and select the wash cycle
- 2** SureClean cleans the printhead with 11 precisely positioned jets
- 3** SureClean dries the printhead to prevent faults



Learn more about Linx SureClean

## Eliminate unscheduled downtime

### Linx SureClean® wash station

11 precisely positioned jets clean critical printhead components and a built-in fan dries it, all in less than 5 minutes. Proactive cleaning with SureClean prevents unplanned stoppages caused by ink build-up by cleaning the printhead thoroughly and consistently.



## Improve operator safety

### Remove manual cleaning

Unlike manual cleaning, Linx SureClean's enclosed unit eliminates operator contact with cleaning fluid, ensuring safe and simple use. It also uses the precise amount of fluid required, reducing waste compared to manual methods.



Before



After

## Clean multiple printers

### Portable device

Easily move the SureClean wash station on its compact, wheeled stand to clean multiple printers. Lightweight and portable, it offers both mains and battery power options for flexible use.



## Reliable printhead by design



Learn more  
about how  
AutoFlush works

No printhead damage

### The most robust printhead

Sealed critical components protect against liquids and harsh environments, with a robust cover tube for added impact protection. Maintenance-free internal parts and curved plates reduce charge concentration and ink build-up.



Built-in automatic cleaning

### AutoFlush cycle

Unique start/stop cleaning routine prevents blocked nozzles, eliminating one of the major causes of unplanned downtime. A smooth transition from solvent to ink prevents ink splashes, reducing daily maintenance with zero solvent waste.



Printhead cleaning reminders

### Customisable cleaning alert

Eliminate unscheduled downtime from common faults by setting custom printhead cleaning reminders. Set reminders by running hours or calendar days to fit your schedule.



Temperature aware

### Automatic jet-speed control

Printhead jet-speed control and temperature sensing for consistent printing in changing ambient temperatures.

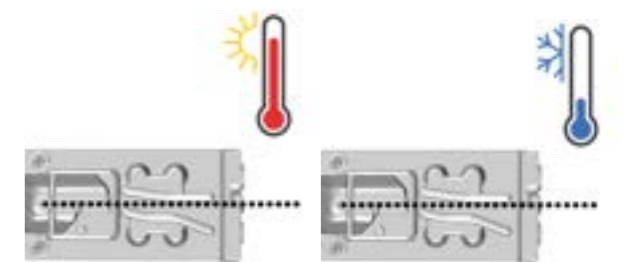

## Built-in battery power for **maximum uptime**



Fast restarts  
even after sudden loss of power

### **Linx PrintProtect® battery backup**

Avoid delayed restarts and blocked printheads if power is suddenly lost. In the case of power interruption or a pulled plug, printing will continue for up to 3 minutes. If power is not restored, a full shutdown routine will run to prevent blocked nozzles.



No missed prints  
even when power is interrupted

### **Linx PrintProtect battery for continuous printing**

Keep printing for up to 3 minutes, even if power is lost or intermittent. No settings are lost, no need to restart the printer, and no missed prints.



Save time on changeovers

### **Linx PrintProtect for line moves**

Save time on moving the 9900 Series printer between lines, no need to wait for shutdown and restart. Get up to 9 minutes to move the printer, with the jet running on battery power, and start printing again immediately.



## Maximise **changeover efficiency**

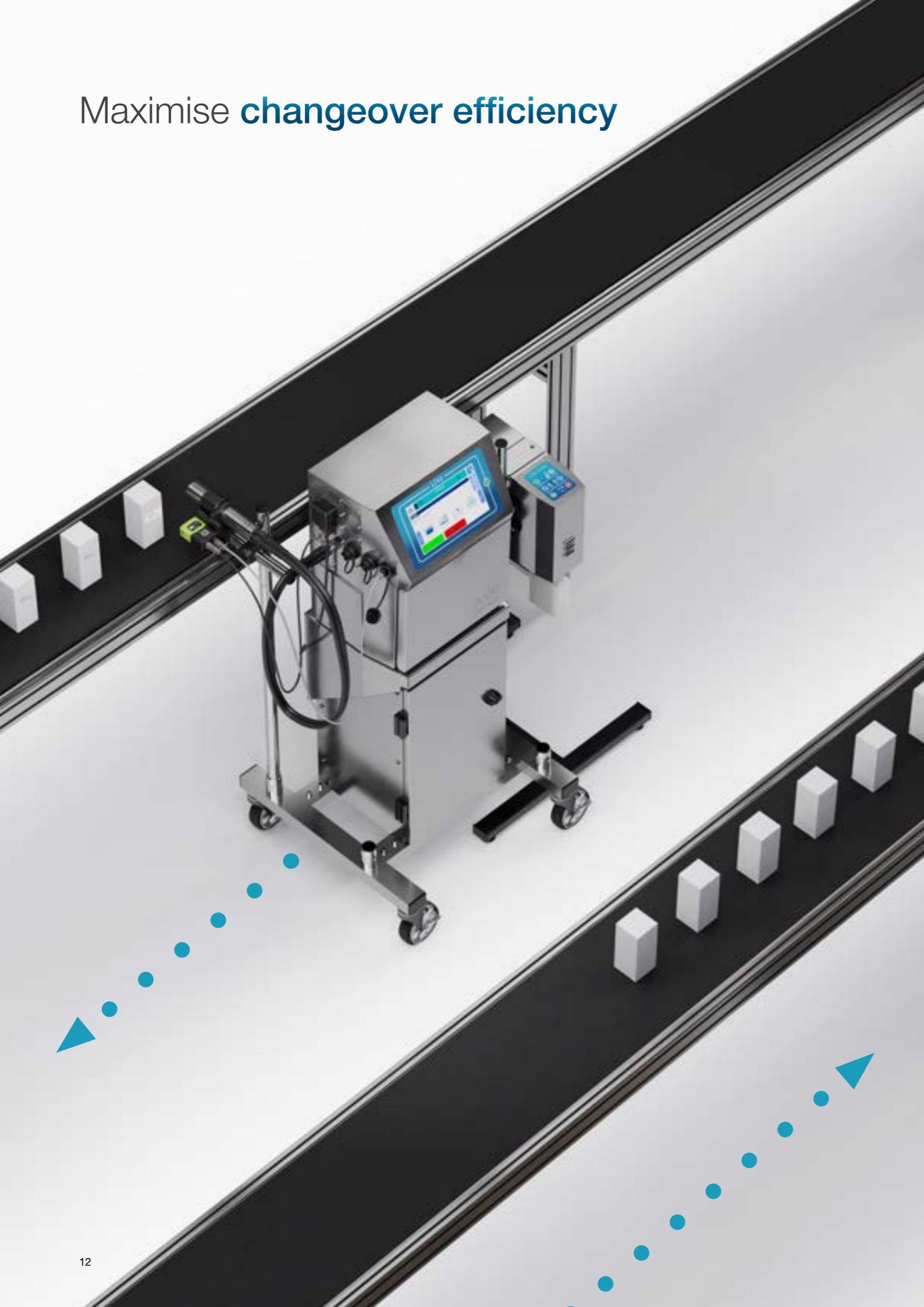

Error-free messages  
from external devices

### **Linx QuickSwitch®**

Change messages in real-time from external production devices or a barcode scanner using Linx QuickSwitch, for fast changeovers and no errors.



Fast message changes from a PC

### **Linx Message Studio™**

Create, edit and switch messages in seconds, using the Linx Message Studio PC application, for fast product changeovers. Send messages to the printer over the network or using a USB drive.



Mistake-proof code selection

### **Product picture select**

No need for operators to remember the code requirements for different products; save them to the printer with an easily identifiable product photo for mistake-proof selection.



Rapid, repeatable setup

### **Stored line settings**

Save time by storing up to 50 previously used line settings for quick and efficient changeovers. No need to reconfigure for perfect print. The saved settings can also be saved onto a USB drive to transfer between printers.



# Integrated vision system for **code confidence**

**CORRECT CODE** 

26 NOV  
25276 14:25

Linx Iris will detect:

ABSENT CODE	MISSING CHARACTERS	MISSING PART CHARACTERS	TRUNCATED TEXT	OVERLAPPING CHARACTERS
	2 NOV 252 6 14:25	26 NOV 25276 14:25	26 NOV 25276 14:25	26 NOV 25276 14:25
DISTORTED CHARACTERS	TEXT NOT MATCHING	INVALID DATE	INCORRECT POSITIONING	INCORRECT POSITIONING
26 NOV 25276 14:25	26 NOV 24276 14:25	32 NOV 25276 14:25	NOV 76 14:25	26 NOV 25276 14:25

Every code present and correct

## Linx Iris® vision system

Ensure every product is printed with the correct code and in the correct position, no need for manual code inspection. If a missing or failed code is detected, the printer's alarm outputs can be configured to alert you or stop the production line.



No rework or rejects

## Code quality inspection

Linx Iris ensures that each product is marked with a code that aligns with your quality standards, helping to minimise waste and rework while safeguarding your customer's trust. Set pass criteria and quality level on the printer interface to prevent incorrect failures.

QUALITY LEVEL 5	26 NOV 25276 14:25
QUALITY LEVEL 4	26 NOV 25276 14:25
QUALITY LEVEL 3	26 NOV 25276 14:25
QUALITY LEVEL 2	26 NOV 25276 14:25
QUALITY LEVEL 1	26 NOV 25276 14:25

Easy to set up and use

## No external computer or power source required

The Linx Iris vision system connects directly to the 9900 Series printer and requires no additional hardware or software for installation, training or use. You can train a new code using the camera with simple on-screen guides and view detected codes and pass/fail rate on the printer screen.



Find out more about the Linx Iris vision system

# Simple interface to prevent errors



Easy to use screen

### Intuitive icon-led user interface

Message selection and printer operation is easy with the icon-led interface. Highly responsive touchscreen even when wearing gloves, and an alcohol and solvent-resistant protective membrane for worry-free cleaning.



Ready in your language

### Quick language selection

Enable operators of any nationality to use the Linx 9900 Series printer easily. Switch the language of any screen or instruction instantly with an easily accessible language selector.



GS1® ready

### Unique GS1 Data Matrix code builder

Create error-free GS1-compliant Data Matrix codes using the Linx 9900 Series' mistake-proof, step-by-step GS1 builder tool on the printer interface.



Mistake-free message creation

### Prompted text fields

Ensure that all message data is correctly entered using the customisable prompt fields for standard messages, such as batch codes or dates, with minimum and maximum character limits and limited date ranges.



Most common functions at your fingertips

### Customisable home screen

Quick access to what you need directly from the home screen to fit around your production requirements. For mistake-free operation, lock certain functions from operators with a supervisor level password.



No training required

### On-screen guided maintenance wizards

Enable operators to complete routine maintenance without training, simply follow the instructions and diagrams on the screen.

## Reduce running costs



Use 48% less ink

### 50 micron printhead

Reduce ink use by up to 48% with the 50 micron printhead (option). Using the Linx durable printhead design, the MK11 Mini printhead is capable of printing smaller characters and 2D codes for more print, less ink.

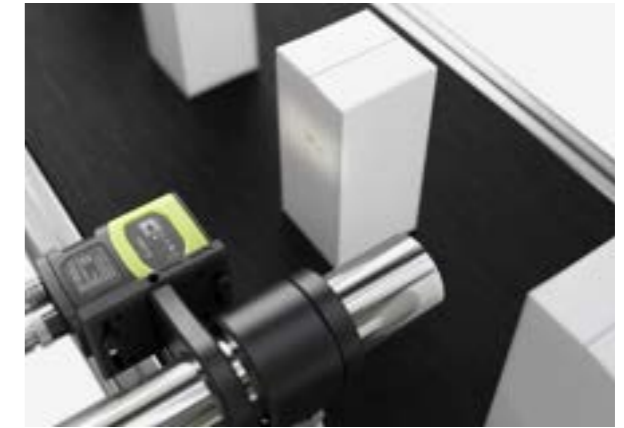

42% solvent reduction

### Active Airflow Control technology

Reduce solvent consumption by up to 42% with built-in Active Airflow Control (AAC) technology for lower running costs and fewer printer refills.



Without AAC

With AAC

Reduce scheduled maintenance

### EasiChange® service module

Service the Linx 9900 Series in 30 minutes with only 0.5 litres of ink changed. It can be completed on an engineer visit or self-serviced to fit your schedule. With up to 24 months between services you can be confident that maintenance is kept to a minimum.



Reduce repair costs

### Components fit for life

Fit-for-life pump and individually replaceable ink system parts reduce repair and replacement costs of key components over the lifetime of the printer.

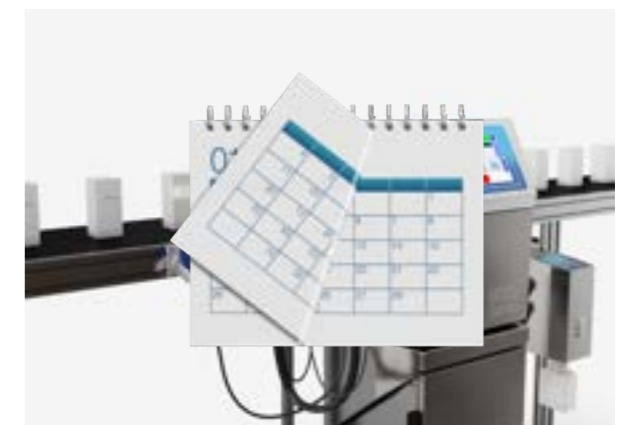

## Other important features

### Connect with IT systems

#### Linx REST API

Easily develop applications to integrate IT systems and equipment systems with Linx 9900 Series printers for automated code set up with the simple, human-readable protocol.

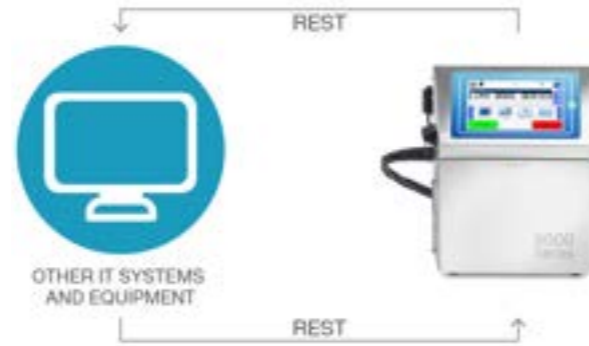

### Never stop printing

#### Extra long fluid refill warnings

Continuously monitor the ink and solvent and receive a warning 12 hours before the fluid runs out, with a live countdown of the remaining printing duration. Refills can be done at any time without interrupting printing.



### Monitor anytime, anywhere

#### Linx PrinterNet®

Check print job status and production insights remotely from a PC, tablet or smartphone. Set up real-time email notifications for printer errors or low fluid levels. Collect data on your production line to plan efficient changeovers and improvements.



### Switch off for longer

#### Extended shutdowns

Shut down the printer for up to 3 months without flushing and draining on restart, ideal for holiday shutdowns or secondary lines.



## Linx 9940 Spectrum for high opacity inks

### Less cleaning, more coding

#### Linx 9940 Spectrum

Power down the Linx 9940 Spectrum for up to a month without flushing or draining, then resume printing immediately. With no daily cleaning and a service interval twice that of other pigmented printers, you'll benefit from reduced maintenance and increased uptime.



### High-quality opaque print

#### Unique Vortex® mixing tank

Ensure clear, opaque print every time. The Vortex mixing tank, with unique contoured shape, collects and re-disperses the pigment in the ink continuously, for high contrast coding.



### Reduce nozzle blockages

#### PureFlow® 5x filtration

Reduce the risk of blockages in the printhead, without loss of opacity, by using the powerful Linx PureFlow continuous filtration system which filters the ink 5 times.

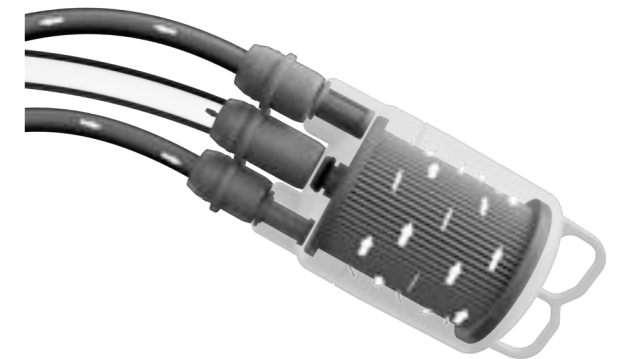

### Ideal for cable and extrusion

#### Metre marking and super-fast print

Accurate metre marking helps to maintain consistent, traceable markings along the full length of cable and extruded plastics. For fast-moving products, the Super-fast tower print style produces clear characters at speeds up to 10 m/s.



# An ink for **any** application

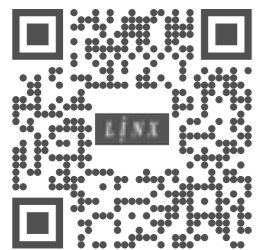

Find out more about Linx inks



### Enhanced EHS compliance inks

Linx offers a range of inks that are MEK-free, halogen-free, non-CMR and PFAS-free. These inks support safer handling, improved workplace air quality, and alignment with evolving regulatory requirements.



### General purpose inks

The Linx range of general purpose inks offers outstanding performance under most common application conditions. They have excellent adhesion and contrast on a wide range of porous and non-porous materials such as paper, card, metal, glass and plastics.



### Coloured inks

The Linx range of coloured inks provide a strong contrast with a range of light and dark substrates. This range includes dye-based inks, and pigmented inks for a more opaque code.

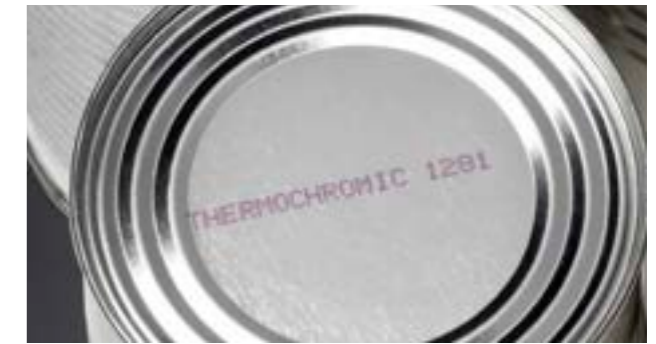

### Process specific inks

Linx has an extensive range of inks designed for more challenging applications where products are subjected to additional processes after coding e.g. sterilisation, fluid washes, chemicals, or curing.



### Plastic substrate inks

Linx inks deliver reliable adherence on rigid and flexible plastics. Each ink is tailored to meet the demands of challenging environments to ensure crisp, lasting codes.



### Security inks

Linx UV fluorescing security inks help manufacturers of high-value goods protect against imitation, while also providing a discreet way to track products through production and packing.

## Print samples

MK11 Mini (50 micron)

5 DOTS 7 DOTS **25 DOTS**

26 NOV 2028 25276 14:25

BATCH NO. SH503867  
MFD:03/12/2030  
EXP:03/12/2030  
RS0384339N09888



MK11 Midi (62 micron)

5 DOTS 7 DOTS 9 DOTS 12 DOTS 16 DOTS 18 DOTS

**21 DOTS 25 DOTS**

**34 DOTS**

5 DOTS BOLD STYLE 7 DOTS BOLD STYLE

5 DOT WIDE STYLE 7 DOT WIDE STYLE 7 DOT WIDE STYLE 7 DOT WIDE STYLE

7 16 25 TALL

Batch No. SH503867 179.00 15250028  
MFD:03/12/2030 USP:Rs.1.00/ml 01/2030-12/2032  
EXP:03/12/2030 BAS001 01/2030  
RS0384339N09888 12/2032

26 NOV 2028 25276 14:25

UK REF:GAL-213 LOT:2501050 MFD:24.05.2030 26 NOV 2028  
CA 2000ML EXP:2032/12 BT144 C07H1 03:49:01 25276 14:25

13 NOV 30 20:35:00 710

BEST BEFORE 07 AUG 2030



MK11 Midi Plus (75 micron)

5 DOTS 7 DOTS 9 DOTS 12 DOTS 16 DOTS

18 DOTS 21 DOTS 25 DOTS

**34 DOTS**

7 16 25 TALL

5 DOT BOLD 7 DOT BOLD STYLE

5 DOT WIDE STYLE 7 DOT WIDE STYLE

0384339N09888

BEST BEFORE 07 AUG 2030 13 NOV 30 20:35:00 710

UK REF:GAL-213 LOT:2501050 MFD:24.05.2030 26 NOV 2028  
CA 2000ML EXP:2032/12 BT144 C07H1 03:49:01 25276 14:25

Batch No. SH503867 179.00 15250028  
MFD:03/12/2030 USP:Rs.1.00/ml 01/2030-12/2032  
EXP:03/12/2030 BAS001 01/2030  
RS0384339N09888 12/2032

Flipped messages, Logos and Barcodes

384339N09888

0384339N09888

*LINK*      

Language characters

撒洒萨塞赛三叁伞散桑扫嫂色涩涩森僧杀  
年月日时分秒前后有效期限生产合格班次  
औ ऐ आ ई ऊ भ ङ ष ध झ ञ ण ओ ए अ इ उ फ र ख थ छ ठ अँ  
Й Ц У К Е Н Г Ш Ц З Х Ъ Ф Ы В А П Р О Л Д  
タ テ イ ス カ ン ナ ニ ラ セ チ ト シ ハ キ ク マ ヌ フ

These are only examples of characters printable, West / East European, Americas and Turkish characters can also be printed.

## Coloured ink samples

Dye based colour samples

For the 9900 Standard Series

Red

Blue

Green

Brown

Purple to Pink thermochemic

Black to blue thermochemic

Pigmented colour samples

For the 9900 Standard Series

Yellow

Pigmented colour samples

For the 9940 Spectrum only

Opaque Blue

Blue Pigmented

High-Opacity Grey

High-Opacity White

## Typical applications



# Popular accessories



**9000 Series stand**  
Compatible with the current standard range of Linx pole-mount accessories for mounting printheads and alarms. Available with either large lockable wheels or adjustable feet.



**9000 Series cabinet**  
Compatible with the current standard range of Linx pole-mount accessories for mounting printheads and alarms. Available with either large lockable wheels, or adjustable feet.



**Mobile floor-mount assembly**  
Freely moveable mount designed to support the printhead or SureClean wash station away from the printer, for example on the opposite side of the production line. Available with either large lockable wheels, or adjustable feet.



**Printhead support assembly**  
The pole slots into the stand or cabinet base so the printhead support can be moved with printer mountings. It includes the following parts:

- Two 0.5 m poles
- 1.0 m pole
- In-line joint
- Cross joint
- Printhead bracket



**Alarm beacon**  
The flashing light can indicate various printer conditions, such as low ink or solvent levels, or disabled print. All alarms feature:

- Flashing frequency: twice per second (2 Hz)
- IP55 rated

They are compatible with the same Linx poles used to support printheads.

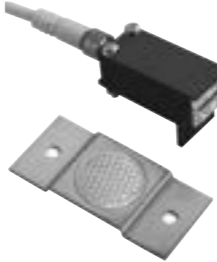

**Product sensors**  
High-performance retro-reflective photocell sensor designed to ensure reliable product detection on production lines. This sensor uses a light beam interruption method to trigger precise coding operations.

- Sensing range of 100–1000 mm
- Response time of 0.5 milliseconds
- IP67-rated housing

Linx offers a full range of accessories to fit your production line needs, including shaft encoders, printhead mountings and connectivity options. Refer to the 9000 Series Accessories Guide for more information.

# Linx SureClean® Automatic printhead wash station

## Technical Specifications

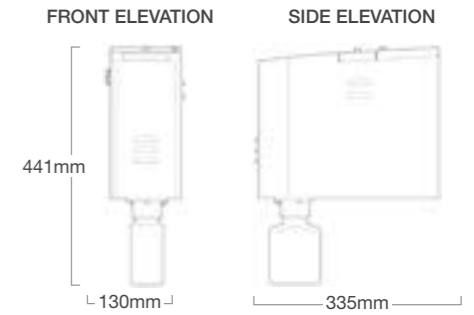

<b>HARDWARE FEATURES</b>	Ergonomic design for easy printhead insertion and one-touch cleaning process start
	Easy select wash cycle, Single-press start and stop wash
	Memory of previously used wash cycle
	LED indicators showing cycle status, battery status (if applicable), cleaning fluid cartridge empty and waste bottle needs replacing
<b>SOFTWARE FEATURES</b>	Guided wizard for SureClean operation on the Linx 9000 Series printer screen
<b>AVERAGE CLEANING CYCLE TIME</b>	<5 minutes
<b>PRINTER COMPATIBILITY</b>	Linx 9000 Series, Linx 8000 Series
<b>PRINthead COMPATIBILITY</b>	MK11 Mini, MK11 Midi, MK11 Midi Plus straight printheads
<b>COMPATIBLE INK TYPES</b>	Dye based, Soft pigmented, Hard pigmented blacks, whites and colours
<b>CLEANING FLUID</b>	Mess-free 0.5 litre cleaning fluid cartridge
	0.5 litre empty bottle for waste collection
<b>ENCLOSURE</b>	Stainless steel
<b>ENVIRONMENTAL PROTECTION RATING</b>	Designed to IP23 (Cabinet), IP54 (Electronics enclosure)
<b>MOUNTING OPTIONS</b>	Wheeled floor stand, Tabletop stand, Bracket for shelf or cabinet mounting*
<b>POWER CONSUMPTION</b>	12W (typical when washing)
<b>POWER SUPPLY</b>	24V wall plug
	Integrated rechargeable Lithium-ion battery (option). Typical number of cleans on battery power - 30. Typical battery recharge time - 4.5 hours
<b>WEIGHT</b>	5kg (without fluids or mount)
<b>REGULATORY APPROVALS</b>	UL

\*Cabinet mounting bracket unavailable in Japan

# Linx Iris® Vision system

## Technical Specifications



<b>INDICATORS</b>	LED indicators showing decode status, Power, Online/Run, Ethernet status	
<b>IMAGE SENSOR</b>	1/4 inch CMOS, global shutter. 1280 x 800, 3.0µm square pixels Monochrome	
<b>ILLUMINATION</b>	Two 2700K white LEDs	
<b>INSPECTION SPEED</b>	Up to 2.5 m/s. 4 prints / second	
<b>INSPECTION DIRECTION</b>	Left and Right. Supports dynamic orientation	
<b>READABLE CODES</b>	<b>MESSAGE CONTENT</b>	Text, Date, Time, Sequential Numbers
	<b>MESSAGE LENGTH</b>	Up to 8cm
	<b>MESSAGE STYLE</b>	Up to 1x21
	<b>FONT SIZE</b>	Up to 2x9
	<b>CHARACTERS</b>	Latin, Extended Latin, Cyrillic, Katakana, Kanji, Hangul, CJK
<b>SOFTWARE FEATURES</b>	Code presence, Code readability, Region of Interest (ROI), Adjustable quality acceptance	
<b>CONNECTIONS</b>	1 x M12 X-Coded 1000/100/10 Mbps Ethernet. 1 x M12 12-pin Power/GPIO/RS-232	
<b>CABLE LENGTH</b>	3m, 6m (option)	
<b>ENCLOSURE</b>	Aluminium	
<b>ENVIRONMENTAL PROTECTION RATING</b>	IP65	
<b>MOUNTING OPTIONS</b>	Quick-release printhead bracket, Quick-release pole-mounted gantry bracket	
<b>OPERATING TEMPERATURE RANGE</b>	0-45°C	
<b>HUMIDITY RANGE (R.H., NON-CONDENSING)</b>	90% max	
<b>POWER SUPPLY</b>	Powered via Linx 9000 Series printer	
<b>WEIGHT (CAMERA ONLY)</b>	195g	
<b>REGULATORY APPROVALS</b>	CE NRTL CAN/CSA FCC BIS	

# Linx 9900 Series

9900 | 9910 | 9920 | 9940 | 9940 Spectrum

## Technical Specifications

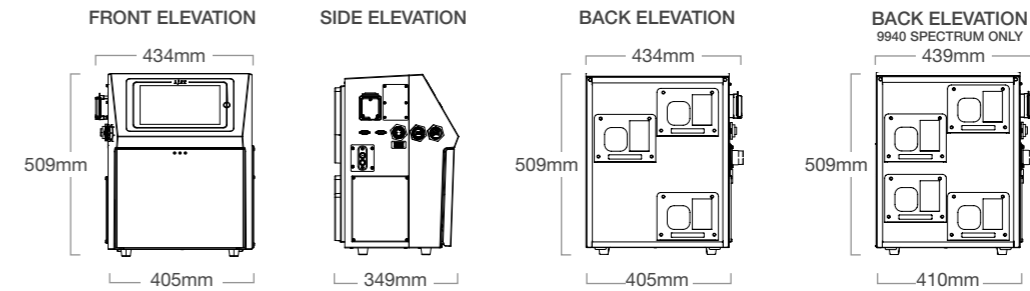
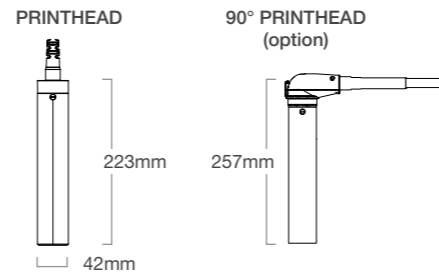

		LINX 9900	LINX 9910	LINX 9920	LINX 9940	LINX 9940 SPECTRUM
<b>LINES OF PRINT</b>		Up to 3			Up to 6	
<b>MK11 MINI PRINTHEAD (50 µm)</b>						
<b>CHARACTER HEIGHT RANGE</b>		1.2mm to 9mm		1.2mm to 11.2mm	1.2mm to 11.2mm	1.2mm to 9mm
<b>MAXIMUM SPEED</b>	<b>ONE LINE PRINT (5 DOT HIGH)</b>	4.39 m/s (0.43mm drop pitch)		6.28 m/s (0.43mm drop pitch)	6.28 m/s (0.43mm drop pitch)	6.28 m/s (0.43mm drop pitch)
	<b>TWO LINE PRINT (7 DOT HIGH)</b>	1.57 m/s (0.43mm drop pitch)		2.19 m/s (0.43mm drop pitch)	2.44 m/s (0.43mm drop pitch)	2.44 m/s (0.43mm drop pitch)
<b>RECOMMENDED DISTANCE FROM SUBSTRATE</b>	(STANDARD)	4mm (8mm available up to 16 dot high printing only)				
<b>MK11 MIDI PRINTHEAD (62 µm)</b>						
<b>CHARACTER HEIGHT RANGE</b>		1.8 to 8.8mm		1.8 to 20mm		1.8 to 16mm
<b>MAXIMUM SPEED</b>	<b>ONE LINE PRINT (5 DOT HIGH)</b>	2.83 m/s (0.37mm drop pitch)	6.25 m/s (0.47mm drop pitch)	6.25 m/s (0.47mm drop pitch)	7.50 m/s (0.47mm drop pitch)	7.50 m/s (0.47mm drop pitch)
	<b>TWO LINE PRINT (7 DOT HIGH)</b>	1.41 m/s (0.37mm drop pitch)	2.09 m/s (0.37mm drop pitch)	2.46 m/s (0.43mm drop pitch)	2.65 m/s (0.43mm drop pitch)	2.65 m/s (0.43mm drop pitch)
<b>RECOMMENDED DISTANCE FROM SUBSTRATE</b>	(STANDARD)	12mm				
	(CARTON CODING MESSAGE STYLE)	35mm				
<b>MK11 MIDI PLUS PRINTHEAD (75 µm)</b>						
<b>CHARACTER HEIGHT RANGE</b>		2.1 to 10.7mm		2.1 to 20mm		2.1 to 17mm
<b>MAXIMUM SPEED</b>	<b>ONE LINE PRINT (5 DOT HIGH)</b>	2.83 m/s (0.44mm drop pitch)	7.28 m/s (0.57mm drop pitch)	7.28 m/s (0.57mm drop pitch)	9.10 m/s (0.57mm drop pitch)	9.10 m/s (0.57mm drop pitch)
	<b>TWO LINE PRINT (7 DOT HIGH)</b>	1.41 m/s (0.44mm drop pitch)	2.02 m/s (0.44mm drop pitch)	2.38 m/s (0.52mm drop pitch)	2.56 m/s (0.52mm drop pitch)	2.56 m/s (0.52mm drop pitch)
	<b>SUPER-FAST TOWER PRINT (5 DOT HIGH)</b>	10 m/s (0.63mm drop pitch)				10 m/s (0.63mm drop pitch)
<b>RECOMMENDED DISTANCE FROM SUBSTRATE</b>	(STANDARD)	20mm				
	(CARTON CODING MESSAGE STYLE)	45mm				
	(HIGH SPEED CABLING)	5mm				
<b>PRINTHEAD</b>	Unique AutoFlush automatic printhead flushing and conduit clearing 2m conduit. 4m conduit (option), 6m conduit (option (not available on MK11 Mini printhead or 9940 Spectrum)). 60mm minimum bend radius in static applications. 180mm minimum bend radius in dynamic applications. 90° printhead with 270° degree adjustable positioning (option), Hydrogen Peroxide resistant conduit (option) Positive air purge for dusty or humid environments (option) Air dryer (provides improved reliability for certain inks at high humidity and temperature) (option)					
<b>SERVICING OPTIONS</b>						
Self-service or engineer visit						
<b>EASI-CHANGE® MODULE SERVICE INTERVAL</b>	<b>DYE BASED</b>	Up to 18 months (13,000 hours)		Up to 24 months (17,400 hours)		
	<b>SOFT PIGMENTED</b>	Up to 12 months (6,000 hours)				
	<b>HARD PIGMENTED</b>	Up to 12 months (8,000 hours)				
<b>SERVICE MONITORING</b>	On-screen system monitoring, to measure key ink system and environmental parameters, to help avoid unscheduled stoppages					
<b>EXTENDED SHUTDOWNS WITHOUT FLUSHING OR DRAINING</b>	Up to 3 months					
<b>LINX PRINTPROTECT® BATTERY</b>	Contains rechargeable Lithium-ion battery as standard					
<b>LINX IRIS® VISION SYSTEM</b>	Compatible with all models (option), refer to Linx Iris Technical Specifications					
<b>LINX SURECLEAN® WASH STATION</b>	Compatible with all models (option), refer to Linx SureClean Technical Specifications					
<b>USER INTERFACE</b>	10-inch full colour touch screen with tough, solvent-resistant polymer cover					
<b>PUMP</b>	Fit-for-life ink pump with no scheduled changes required					
<b>PRODUCTION MEASUREMENT TOOLS</b>	Linx PrinterNet® printer health and production monitoring with remote control (VNC) (option)					
	Total print count, message count and batch count. On-screen output rate measurement and production stoppage log. Downloadable onto USB device					

	LINX 9900	LINX 9910	LINX 9920	LINX 9940	LINX 9940 SPECTRUM
<b>USER INTERFACE FUNCTIONS</b>	Password-protected functions, with customisable user profiles				
	Quick operator language selection from all screens, secondary keyboard for multi-language printing				
	Simple on-screen guidance wizards for multiple functions including line speed and shaft encoder setup, printhead cleaning, and fluid refill				
<b>MESSAGE CREATION</b>	Prompted fields for one-step message editing with customisable on-screen prompts, Automatic date forward function (Add seconds, minutes, or hours to current time, or days, weeks, or months to current date), Height, width and delay functions for easy code sizing and positioning, Shift coding (message content changes automatically at defined times)				
	'Production Schedule' function, to print a sequence of messages automatically, with different triggering and repeat print options				
	Message selection, creation and editing from a PC using Linx Message Studio®				
<b>MEMORY</b>	GS1 Data Matrix code builder				
	Up to 1000 messages can be stored using internal printer memory, more can be stored on a USB storage device				
	Up to 4 line settings can be stored, with individual line names		Up to 50 line settings can be stored, with individual line names		
<b>MESSAGE SELECTION</b>	Message, line and printer settings backup, copy and restore using USB storage device				
	QuickSwitch® message selection, remote field update and message select-and-populate text field, using barcode scanner				
	Message selection using product images				
<b>PRINT CAPABILITIES</b>	Text, Symbols, Numbers, Dates, date rounding (using the printer's internal clock), Times, Graphics, Logos				
	Rotated character (tower) printing, Inverted printing, Bold character printing (up to 9 times)				
	Variable character spacing and inverse image printing, for improved readability and vision system recognition				
	Sequential numbering (forward and backward counting, variable intervals)				
	Sequential numbering (multiple number ranges, alphanumeric sequencing)				
	One-touch sequential number reset option from the printer screen, and reset using external trigger				
	Barcodes (ITF 2 of 5, Code 39, Code 128, EAN 13, EAN 8, UPCA, Pharmacode, Data Matrix, GS1 Data Matrix, QR, RM4SCC-Type C)				
<b>INK AND SOLVENT</b>	Dynamic orientation for printing on traverse applications (option)		Dynamic orientation for printing on traverse applications		
	Accurate marking at regular intervals i.e. 'metre marking', with rollback to detect lines running backwards and high precision calculation options				
	Sequential text fields, increment and reset sequences using external triggers, optional one-touch sequence reset from the printer screen				
<b>CONNECTIONS</b>	On-screen fluid level indicators, up to 12 hour running from fluid refill warning to printer stop				
	Mistake-proof, mess-free ink and solvent refills while printing (0.5 litre ink cartridge, 1 litre solvent cartridge)				
	Dye based black and colours. Soft pigmented colours				Hard pigmented white and colours
<b>BASE &amp; ENCLOSURE</b>	Active Airflow Control for lower solvent consumption and reduced emissions (option (not available on 6m printheads))				
	Multiple protocols to connect with other equipment including REST interface, Extended QuickSwitch and RCI				
	2 x D-type connectors for Product Detector, Shaft encoder/Second product detector, Quadrature encoders for direction applications, and Vision camera				
	Alarm connector for External single stage alarm output (24v)				
	Ethernet for Linx Remote Communications Interface (RCI), Extended QuickSwitch®, REST, Linx Message Studio and Linx PrinterNet				
<b>ENVIRONMENTAL PROTECTION RATING</b>	USB for Graphics and logos import, Data backup, Barcode scanner and Wi-Fi Connection for Linx PrinterNet				
	RS232 (option), Parallel I/O (option), Volt-free contact alarm connection (option), Multi-stage Alarm output (24v and volt free) (option)				
<b>OPERATING TEMPERATURE RANGE</b>	5-45°C (0-50°C for Linx 1240, 1010, 1014 and 3240 ink types)				5-45°C
<b>HUMIDITY RANGE (R.H., NON-CONDENSING)</b>	90% max				
<b>POWER SUPPLY</b>	100-230V, 50/60Hz				
<b>POWER CONSUMPTION</b>	38W (typical when printing)				
<b>POWER RATING</b>	120W				
<b>WEIGHT</b>	23.2kg (including fluids and 2m printhead)				25.1kg (including fluids and 2m printhead)
<b>REGULATORY APPROVALS</b>	GS CE UL CAN/CSA FCC BIS				

Linx 9900 Series



Linx Iris®



Linx SureClean®



**L I N X**

**Making printing  
one less thing  
to worry about**

Linx PrinterNet®



Linx Ink Range



Global Support Network

**Global Sales**

+44 (0)1480 302100  
sales@linxglobal.com

**UK Sales**

+44 (0)1480 775 223  
uksales@linx.co.uk

**France Sales**

+33 1 72 07 17 05  
info@linx.fr

**China Sales**

021-80504700  
chinasales@linxglobal.com

